

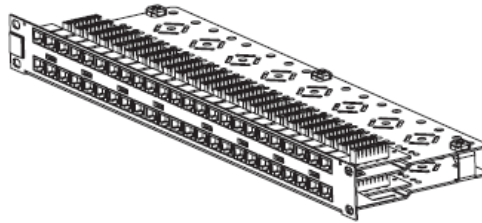

POWER CAT 1U HIGH DENSITY PATCH PANEL EUROPEAN INSTALLATION



1.0 SCOPE

This document provides installation instructions of Power Cat 1U High Density Patch Panel for European

2.0 PROCEDURE

2.1 ASSEMBLY INSTRUCTIONS

Tools required.

110 TERMINATION TOOL SET ON LOW IMPACT.



1. Preparation

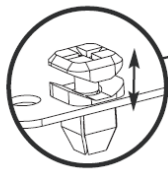
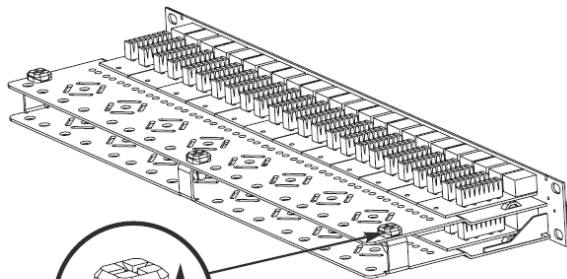

Release snap-fit fasteners

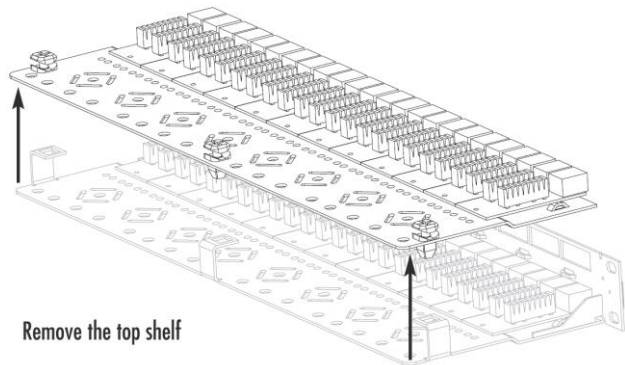

Remove the top shelf

2. Termination

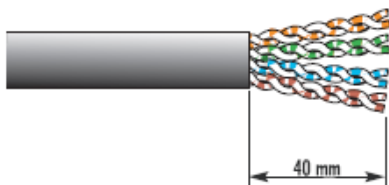

40 mm

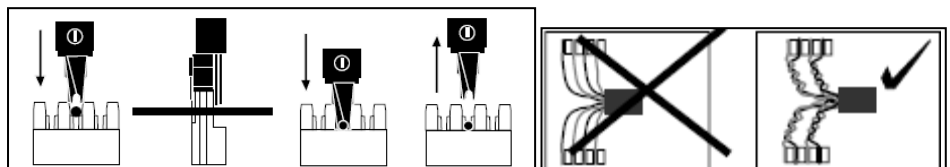

3. Color Coding

EC/ECM NO: 115310	SAP NO : 187000389	Doc No: AS-18700-083 Doc part: AS	REV- A2
SAP EC NO: 10832335	http://www.molexces.com/		DATE: 2017/MAY/11

568A

F	D	E	NL	GB	Jack Pin
blanc/bleu	weiß/blau	blanco/azul	wit/blauw	white/blue	5--
bleu	blau	azul	brau	blue	4--
blanc/vert	weiß/grun	blanco/verde	wit/groen	white/green	1--
vert	grun	verde	groen	green	2--
blanc/orange	orange/weiß	blanco/naranje	wit/oranje	white/orange	3--
orange	orange	naranje	oranje	orange	6--
blanc/marron	weiß/braun	blanco/marron	wit/bruin	white/brown	7--
marron	braun	marron	bruin	brown	8--
*	*	*	*	drain wire	Shield

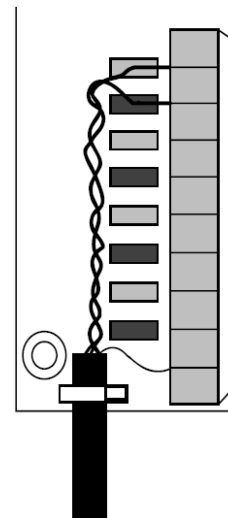

568B

F	D	E	NL	GB	Jack Pin
blanc/bleu	weiß/blau	blanco/azul	wit/blauw	white/blue	5--
bleu	blau	azul	brauw	blue	4--
blanc/orange	weiß/orange	blanco/naranje	wit/oranje	white/orange	1--
orange	orange	naranje	oranje	orange	2--
blanc/vert	weiß/grun	blanco/verde	wit/groen	white/green	3--
vert	grun	verde	groen	green	6--
blanc/marron	weiß/braun	blanco/marron	wit/bruin	white/brown	7--
marron	braun	marron	bruin	brown	8--
*	*	*	*	drain wire	Shield

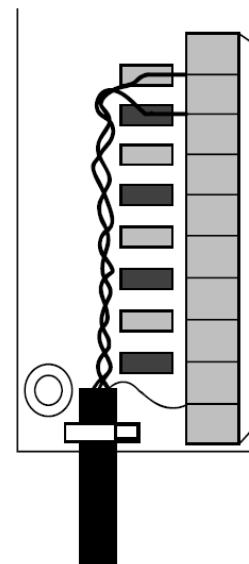

4. Cable Dressing

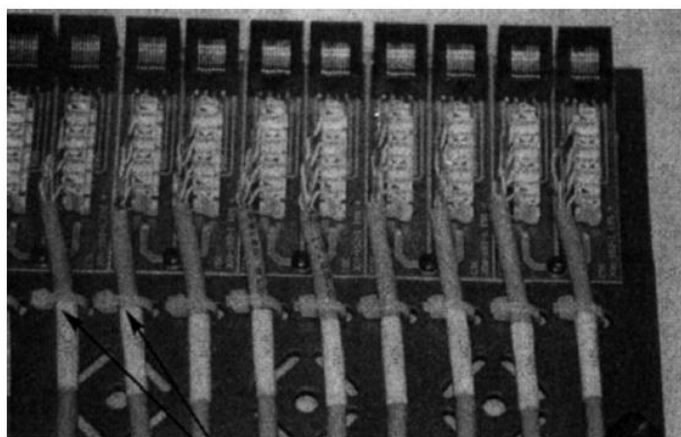

Cable Tie



Dress cable with a service loop to allow for panel inspection or test.



Dress cable to the left bottom shelf to the right on the top shelf.

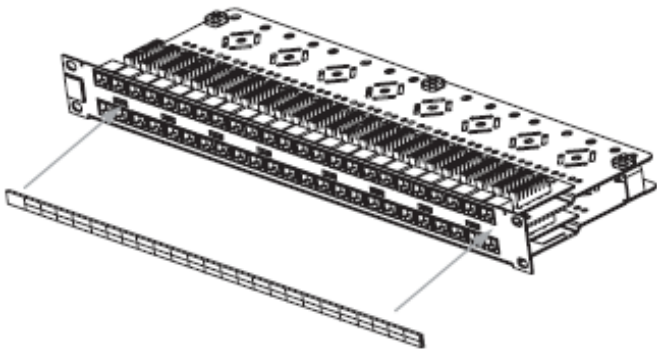

Attach self-adhesive label



POWER CAT 48 PATCH PANEL

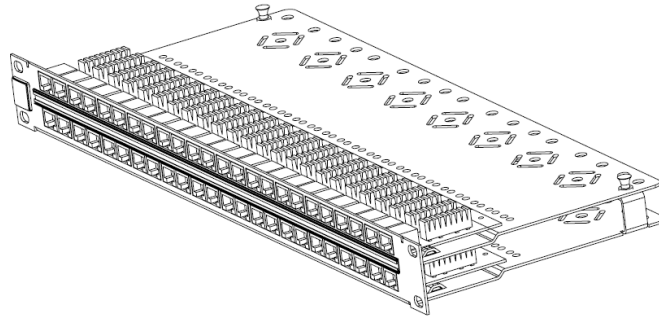

1.0 SCOPE

This document provides installation instructions of Power Cat 48 Port Patch Panel.

2.0 PRODUCT DESCRIPTION

- This is Power Cat 48 Port Patch Panel.

3.0 PROCEDURE

3.1 ASSEMBLY INSTRUCTIONS

- **Tools required.**

110 TERMINATION TOOL SET ON LOW IMPACT.



1. UTP

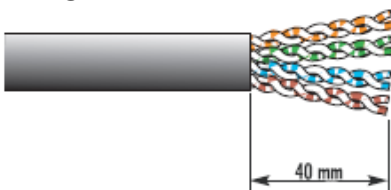

2.

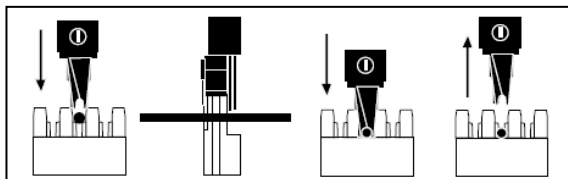

3.

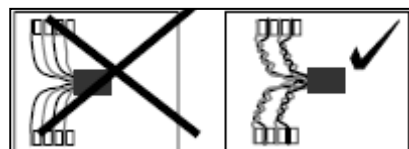

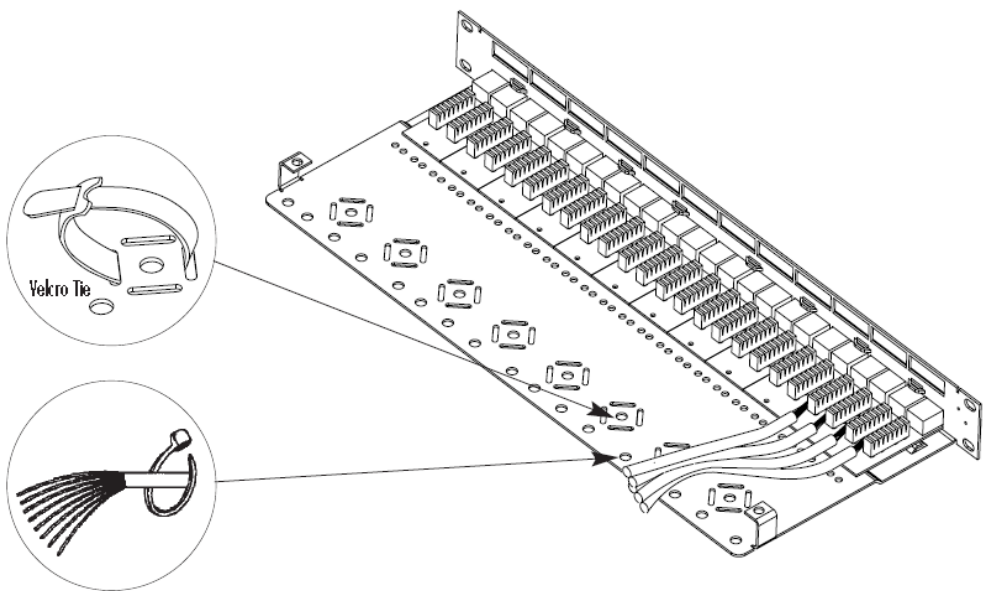

4a.

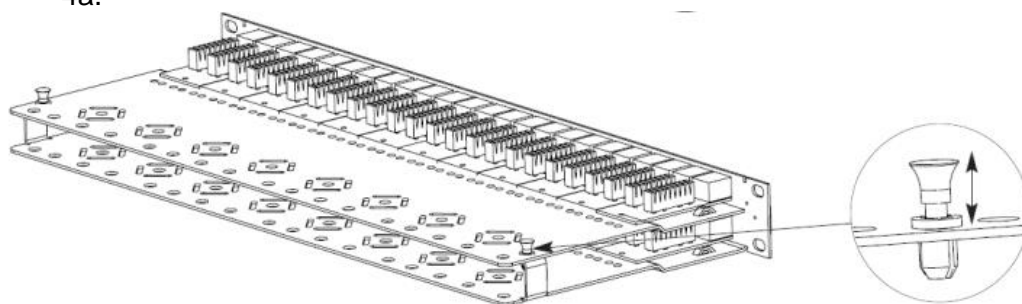

4b.

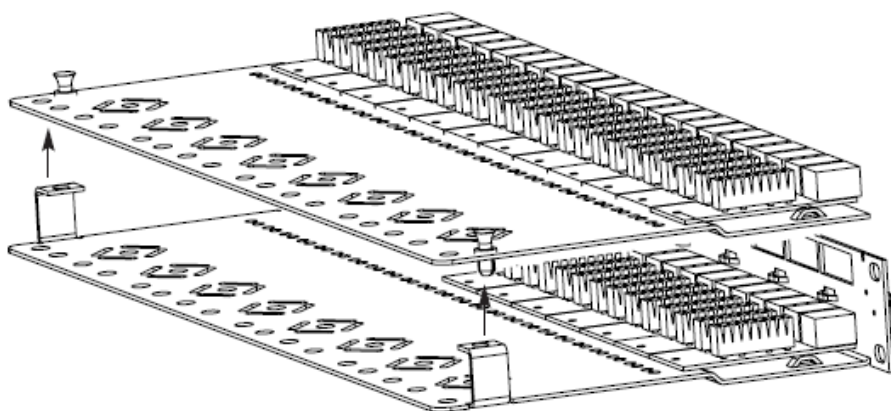

4c.

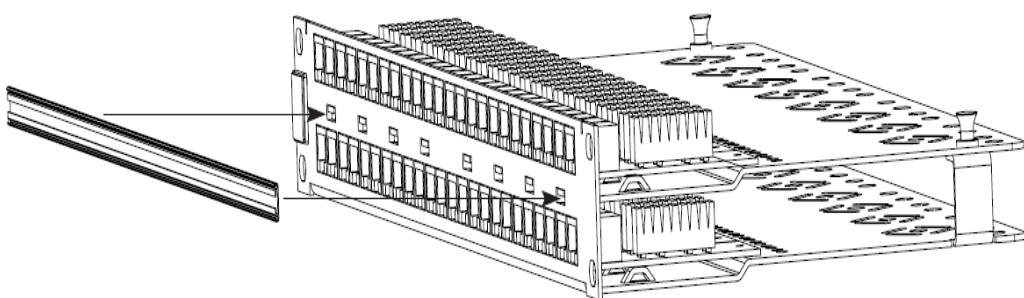

568A

F	D	E	NL	GB	Jack Pin
blanc/bleu	weiß/blau	blanco/azul	wit/blauw	white/blue	5--
bleu	blau	azul	brau	blue	4--
blanc/vert	weiß/grun	blanco/verde	wit/groen	white/green	1--
vert	grun	verde	groen	green	2--
blanc/orange	orange/weiß	blanco/naranje	wit/oranje	white/orange	3--
orange	orange	naranje	oranje	orange	6--
blanc/marron	weiß/braun	blanco/marron	wit/bruin	white/brown	7--
marron	braun	marron	bruin	brown	8--
*	*	*	*	drain wire	Shield

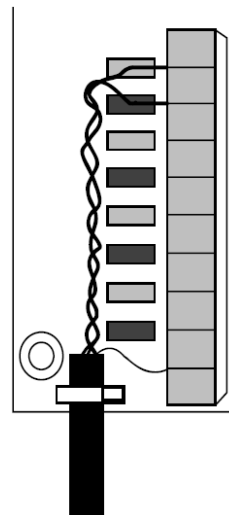

568B

F	D	E	NL	GB	Jack Pin
blanc/bleu	weiß/blau	blanco/azul	wit/blauw	white/blue	5--
bleu	blau	azul	brauw	blue	4--
blanc/orange	weiß/orange	blanco/naranje	wit/oranje	white/orange	1--
orange	orange	naranje	oranje	orange	2--
blanc/vert	weiß/grun	blanco/verde	wit/groen	white/green	3--
vert	grun	verde	groen	green	6--
blanc/marron	weiß/braun	blanco/marron	wit/bruin	white/brown	7--
marron	braun	marron	bruin	brown	8--
*	*	*	*	drain wire	Shield

