

30P Voice Patch Panel UTP 1U Installation Instructions

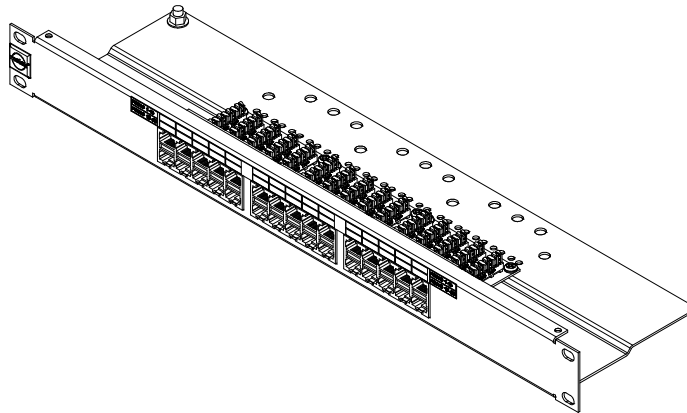

| Order No. | SAP No. | Description |
|---------------|-----------|------------------------------|
| PID-00145-30P | 180810026 | 30P Voice Patch Panel UTP 1U |

Included Items

- IDC patch panel
- Cable ties
- Screw / cage nut / washer kit
- Installation Instruction.

1.

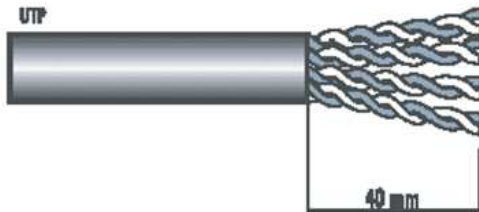

2.

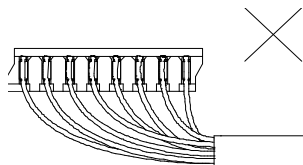
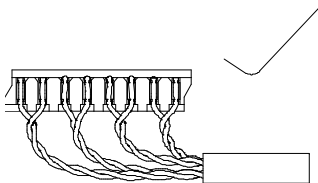
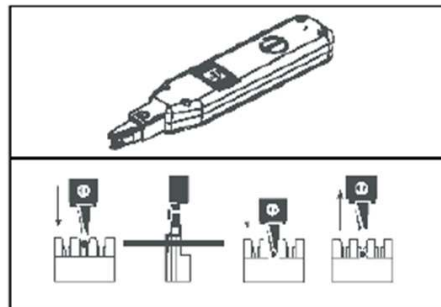

| MPN NO. | SAP NO. |
|---------|-----------|
| 215-389 | 187000371 |

| | | | |
|---|---|---|---|
| REVISION: A1 | ECR/ECN INFORMATION: EC No: MTS2013-0071 DATE: 2013 / 07 / 16 | TITLE: P Voice Patch Panel UTP 1U Installation Instructions | SHEET No. 1 of 2 |
| DOCUMENT NUMBER: AS-18700-068 | CREATED / REVISED BY: Snagaravenka | CHECKED BY: CG, Raghavan | APPROVED BY: Krzysztof Ojdana |

3.

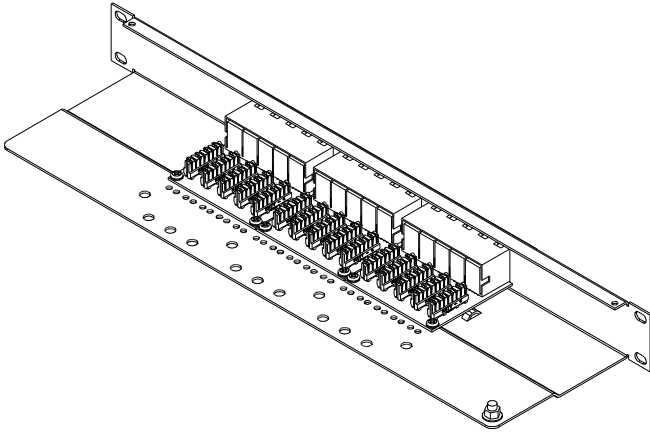

4.

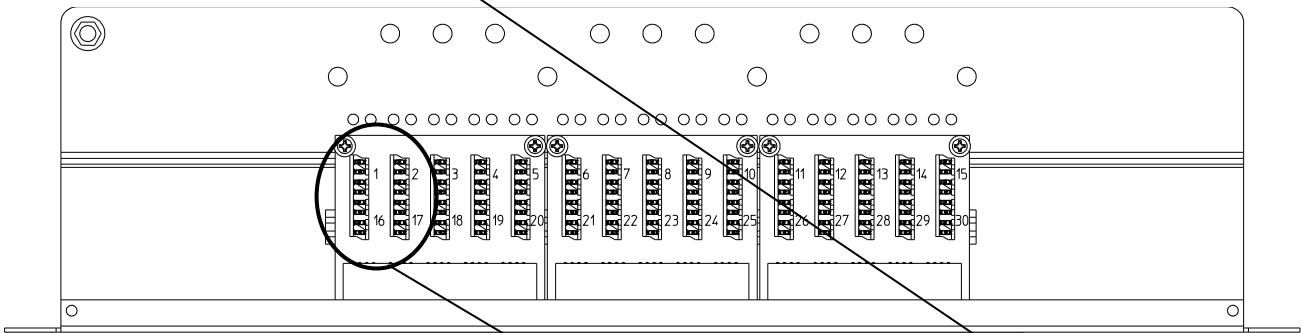
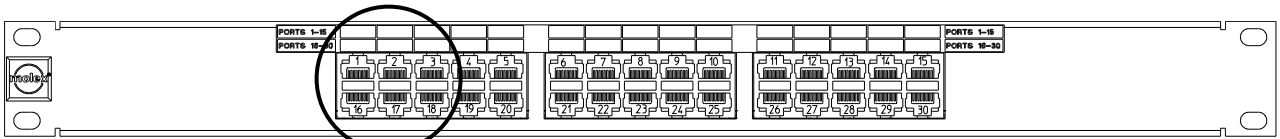

USOC 2PR (4W)

| F | D | E | NL | GB |
|--------------|-------------|----------------|------------|--------------|
| orange | orange | naranja | oranje | orange |
| blanc/orange | weiß/orange | blanco/naranja | wit/oranje | white/orange |
| bleu | blau | azul | blauw | blue |
| blanc/bleu | weiß/blau | blanco/azul | wit/blauw | white/blue |
| orange | orange | naranja | oranje | orange |
| blanc/orange | weiß/orange | blanco/naranja | wit/oranje | white/orange |
| bleu | blau | azul | blauw | blue |
| blanc/bleu | weiß/blau | blanco/azul | wit/blauw | white/blue |

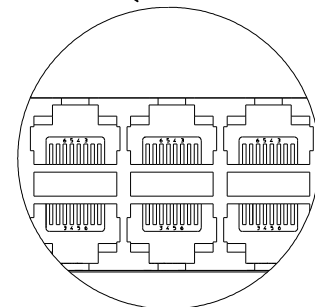
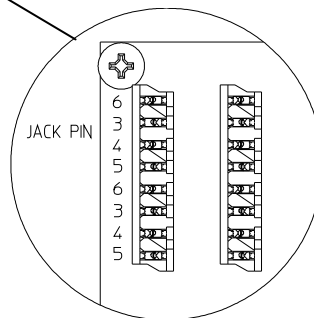

| MPN NO. | SAP NO. |
|---------|-----------|
| 215-389 | 187000371 |

REVISION:

A1

ECR/ECN INFORMATION:

EC No: **MTS2013-0071**

DATE: **2013 / 07 / 16**

TITLE:

**P Voice Patch Panel UTP 1U
Installation Instructions**

SHEET No.

2 of 2

DOCUMENT NUMBER:

AS-18700-068

CREATED / REVISED BY:

Snagaravenka

CHECKED BY:

CG, Raghavan

APPROVED BY:

Krzysztof Ojdana