

CoreSync Compact Driver

The CoreSync Compact Driver is a low voltage, DC/DC LED driver that can be programmed to specific power outputs, for driving Constant Current LED engines in a wide variety of light fixtures. Controlled and powered by a Molex CoreSync Gateway.

The CoreSync Compact Driver can be embedded in a fixture or placed remotely. The Driver is connected to the CoreSync Gateway using rugged and reliable CoreSync Harness.

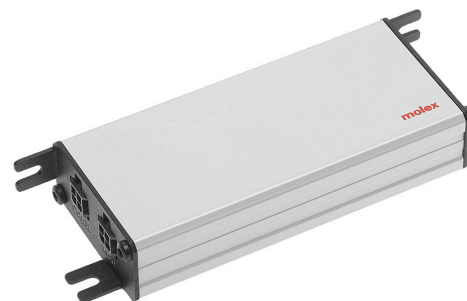

FEATURES AND ADVANTAGES

CoreSync enabled	Easy integration with Molex CoreSync control system
Class 2 device	Low voltage PoE infrastructure for power, control, and communication
Six programmable output current variants	Maximum flexibility and efficiency from 250mA through 1050mA
Integrated power monitoring	Provides valuable energy-use information
Individually addressable	Allows easy discovery, commissioning and control of each driver
Single and dual-channel options	Enables color-tuning and related lighting schemes, such as circadian rhythm
Dual CoreSync IO connectors	Daisy chain capable, easy connection to all CoreSync devices
UL2108 Listed	Safe operation and industry standard compliance

SPECIFICATIONS

Electrical

LED output voltage range: 12 -42VDC*

Standby power: 0.7W

Efficiency: 92% (typical) at 52V DC input, full load

Constant current regulation:

3% over-voltage input variation

Constant current accuracy: ±3%

Commercial Standards

Class 2 electrical device

UL2108 Listed, CSA22.2 No.9.0

FCC Part 15 Subpart B

CE, Plenum compliant

UKCA, BIS

Product Safety

Output over-current protection

Output over-voltage protection

Internal over-temperature protection

DO NOT hot swap

Mechanical

Housing material: Extruded aluminum

Color: Silver-gray

Length: 95.10 mm / 3.74 in

Width: 42.00 mm / 1.65 in

Depth: 18.80 mm / 0.74 in

Weight: 98g / 3.46 oz

Environmental

Ambient temperature:

0 to 40°C (32 to 104°F)

Storage temperature:

-40 to 85°C (-40 to 185°F)

Max case temperature: 75°C (167°F)

Relative humidity:

10-80% non-condensing

Environmental rating: Indoor

Dimming Performance

Dimming: PWM

Dimming type: Linear

Dimming frequency: 500Hz

Dimming range: 1-100%

*The guaranteed output voltage of the driver is in the range of 12-42VDC, however it may support the higher voltages depending upon the overall distance. Please refer to CoreSync harness length calculator to find the maximum voltage allowed.

www.molex.com/products/coresync

CoreSync Compact Driver >

CONNECTION INTERFACES

Connection	Connection Specification
CoreSync Input	4-Pin micro-fit 3.0 connector for CoreSync harness
CoreSync Output	4-Pin micro-fit 3.0 connector for CoreSync harness
LED Output	Poke-in connector, stranded-tinned or solid core, 20-22AWG, 6mm strip length • Single channel: CH1 – LED fixture, NTC – not used • Dual channel: Color tuning mode CH1 – warm channel, CH-2- cool channel, NTC – not used • Dual channel: Dual mono mode (only applicable for 300, 350,500 and 700mA drivers) CH1 – LED fixture1, CH2 – LED fixture 2, NTC- not used

CoreSync IO

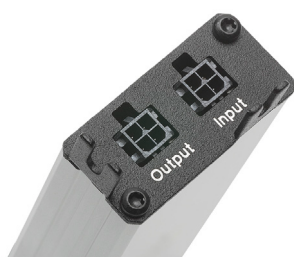

LED Output

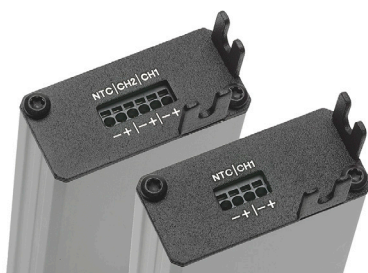

Daisy Chain



Connection Diagram

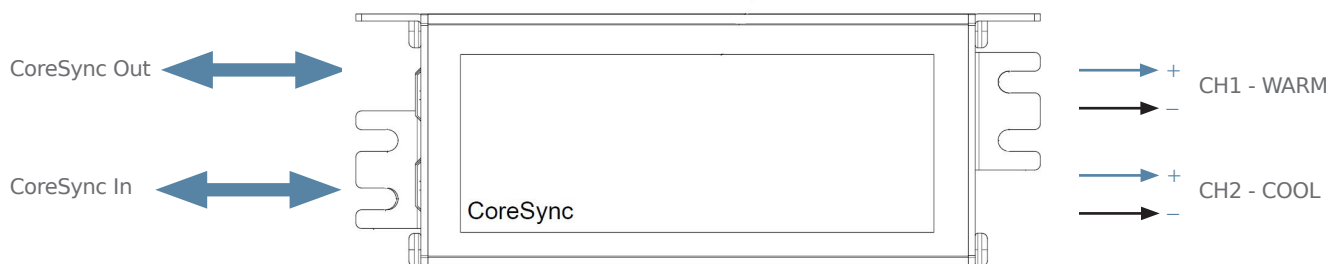

www.molex.com/products/coresync

CoreSync Compact Driver ➤

Connection Diagram

Offset Mounting

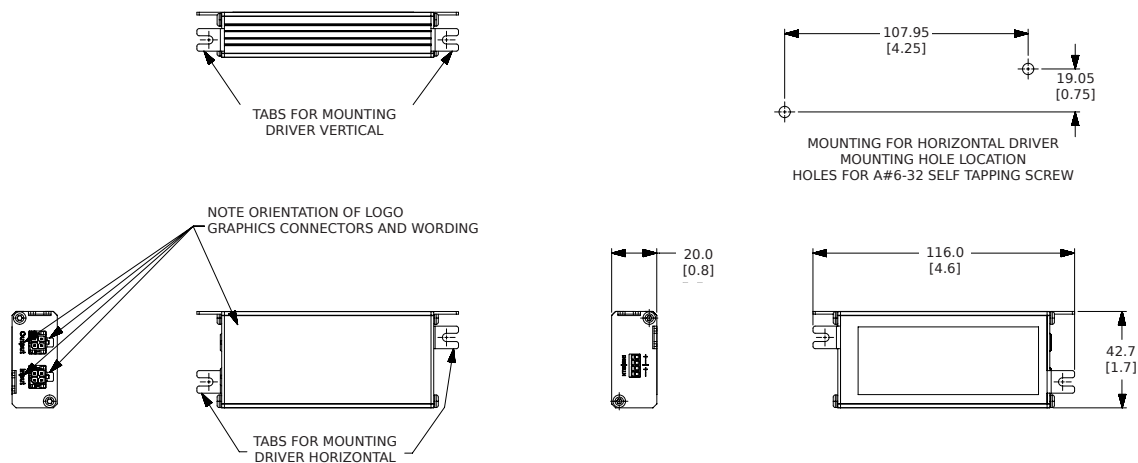

Center Mounting

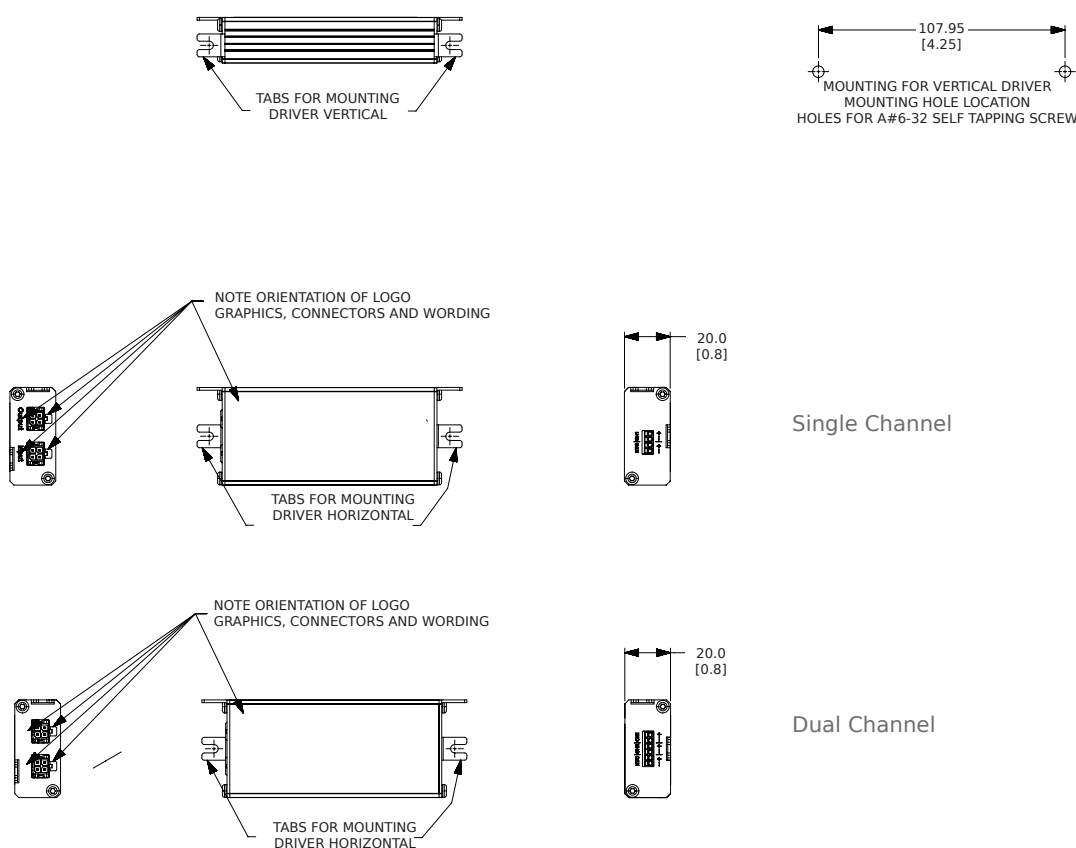

www.molex.com/products/coresync

Molex is a registered trademark of Molex, LLC in the United States of America and may be registered in other countries; all other trademarks listed herein belong to their respective owners. This information is correct at the time of publication, specifications are subject to change.

CoreSync Compact Driver ➤

Performance

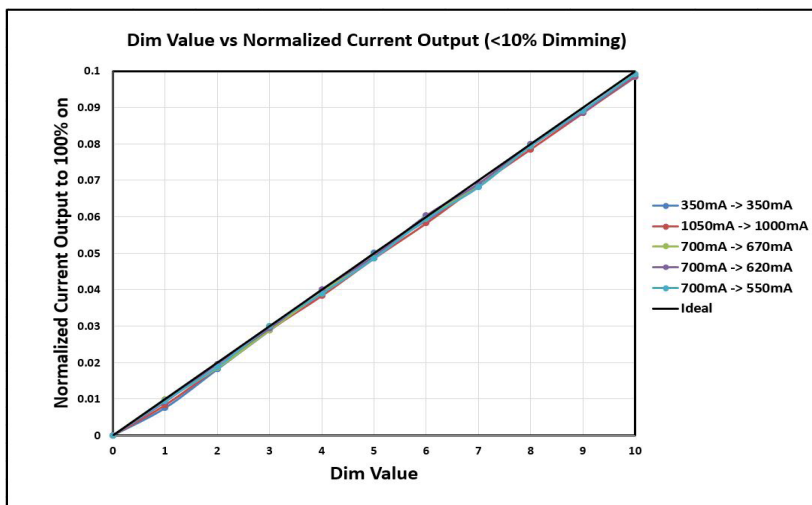
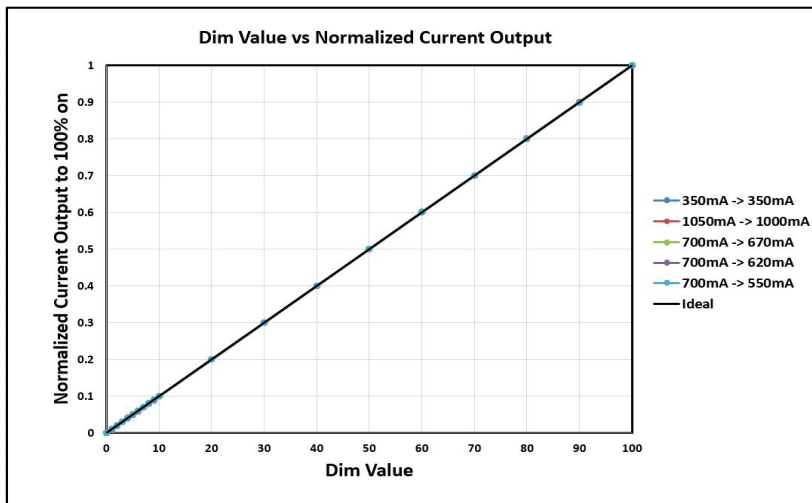
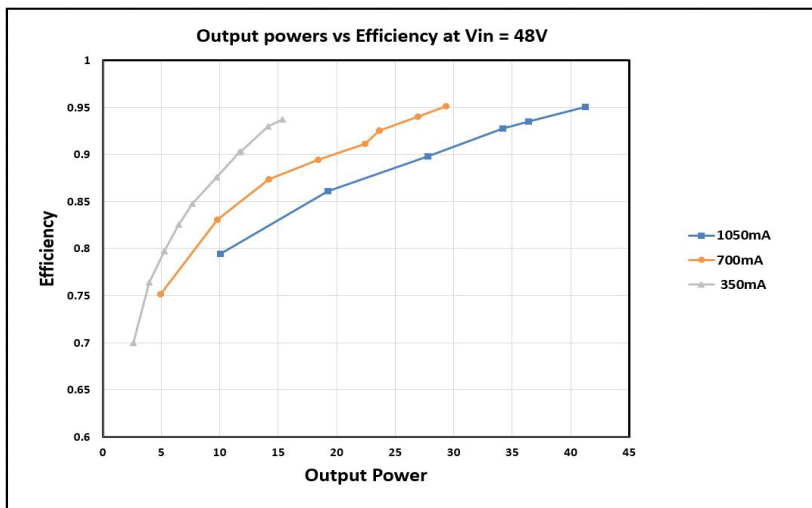

www.molex.com/products/coresync

CoreSync Compact Driver

ORDERING INFORMATION

Order No.	Description	Output Current (mA)	Accuracy	Typical Efficiency at Full Load (%)	Output Voltage
180996-5107	CoreSync Compact Driver, Single, 300mA	250 - 300mA	±3%	94	12-42VDC*
180996-5101	CoreSync Compact Driver, Single, 350mA	300 - 350mA			
180996-5102	CoreSync Compact Driver, Single, 500mA	360 - 500mA		95	
180996-5103	CoreSync Compact Driver, Single, 700mA	510 - 700mA			
180996-5106	CoreSync Compact Driver, Single, 880mA	710 - 880mA			
180996-5104	CoreSync Compact Driver, Single, 1050mA	890 - 1050mA		94	
180996-6107	CoreSync Compact Driver, Dual, 300mA	250 - 300mA			
180996-6101	CoreSync Compact Driver, Dual, 350mA	300 - 350mA		95	
180996-6102	CoreSync Compact Driver, Dual, 500mA	360 - 500mA			
180996-6103	CoreSync Compact Driver, Dual, 700mA	510 - 700mA			
180996-6106	CoreSync Compact Driver, Dual, 880mA	710 - 880mA			
180996-6104	CoreSync Compact Driver, Dual, 1050mA	890 - 1050mA			

* Programmable in 10mA increments, using CoreSync Programming Kit No. 180788-1000.

RELATED PRODUCTS

Molex Series	Description	Gauge / conductor	Start	End	Plenum rated Cable
180777, 180778	CoreSync Daisy-Chain	18/4	10-pin Micro-Fit receptacle	4-pin Micro-Fit receptacle	No
180887, 180888	CoreSync Gateway to Driver		10-pin Micro-Fit receptacle	4-pin Micro-Fit receptacle	No
182105	CoreSync Gateway to Driver, Reverse Gender		10-pin Micro-Fit receptacle	4-circuit Micro-Fit plug	No
182106	CoreSync Extender, 2- Gender		4-pin Micro-Fit receptacle	4-circuit Micro-Fit plug	No
182110-4XXX *	CoreSync Long-Run Cable	18/4	4-pin Micro-Fit receptacle	4-pin Micro-Fit receptacle	Yes
182110-5XXX *	CoreSync Poke-In Extender		4-pin Micro-Fit receptacle	4-way Poke in	Yes
182110-6XXX *	CoreSync Extender, 2- Gender		4-pin Micro-Fit receptacle	4-circuit Micro-Fit plug	Yes

* See individual data sheets for specific order numbers

www.molex.com/products/coresync

Molex is a registered trademark of Molex, LLC in the United States of America and may be registered in other countries; all other trademarks listed herein belong to their respective owners. This information is correct at the time of publication, specifications are subject to change.

CoreSync Compact Driver >

TYPICAL APPLICATION

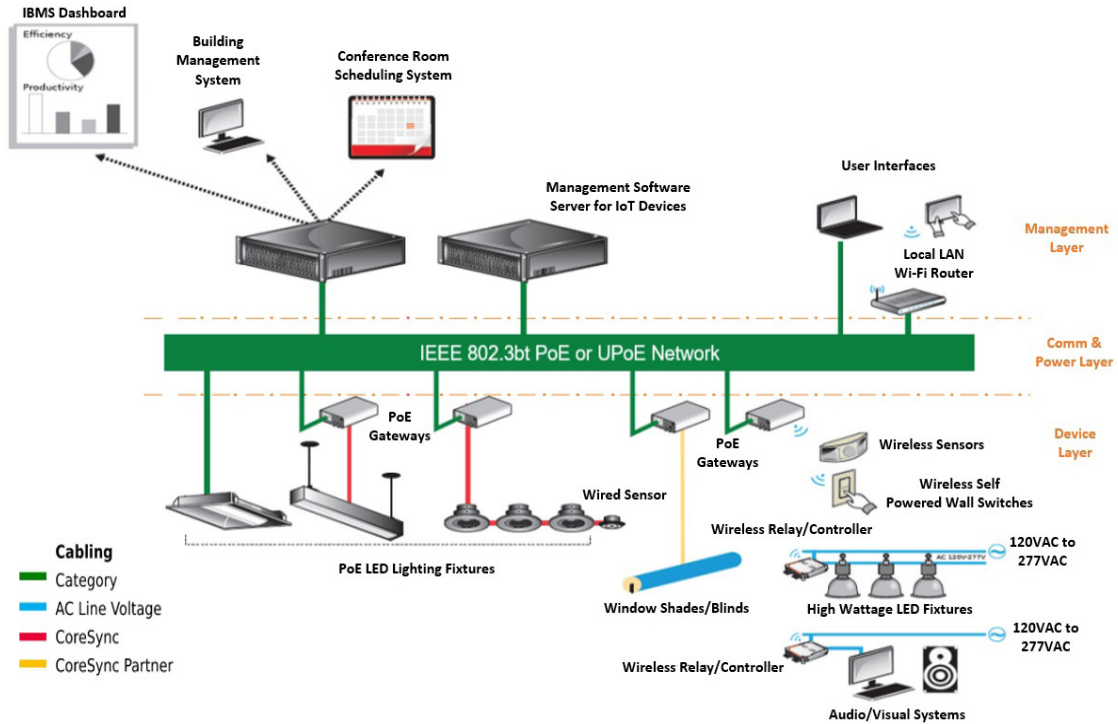

DAISY-CHAINING

The CoreSync PoE Gateway 90W receives power and data from a PoE Network Switch via Category cable. From the PoE Switch, the minimum guaranteed power at the input of the PoE Gateway 90W is 71.3W. If the total power requirement on the Gateway is below 71.3W for the IEEE 802.3bt 90W standard, a single PoE Gateway 90W can power and control multiple LED Drivers, sensors, and other CoreSync devices in a Daisy-Chain configuration, with the easy-to-use input and output connector scheme. Each CoreSync Daisy-Chain device can be powered and physically connected to a CoreSync PoE Gateway 90W with a rugged and reliable Molex CoreSync Harness cable, using a Molex Micro-Fit 3.0 4-pin connection.

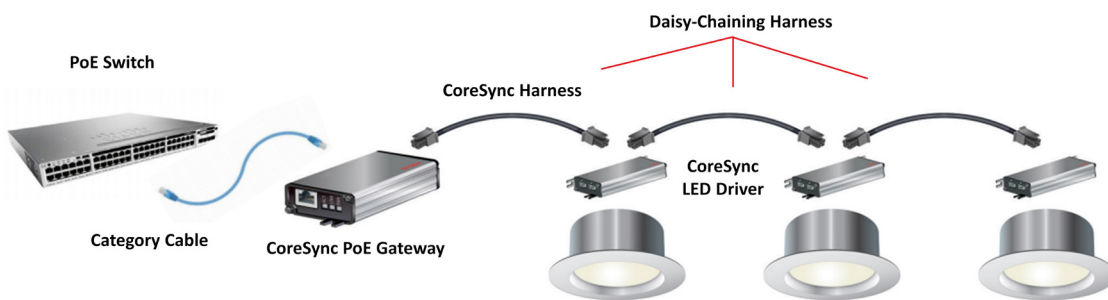

The total power budget on the Gateway must comply with the IEEE 802.3bt standard, and considers the load power, power drop on CoreSync devices in the Daisy-Chain—including the Gateway, and interconnect losses. The overall voltage drop and power drop can be calculated prior to the design. Please refer to CoreSync Harness Length Calculator to calculate the maximum run distance.

www.molex.com/products/coresync